

ME6211C33M5G 线性稳压器

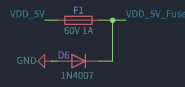

过流 & 防反接



DAPLink 固件下载

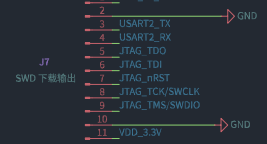

SWD/JTAG 输出

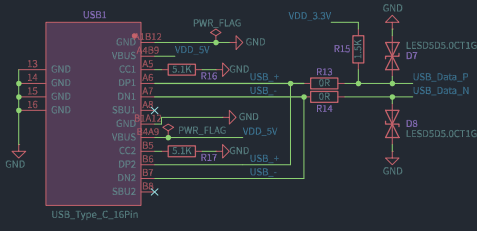

USB Type-C 接口

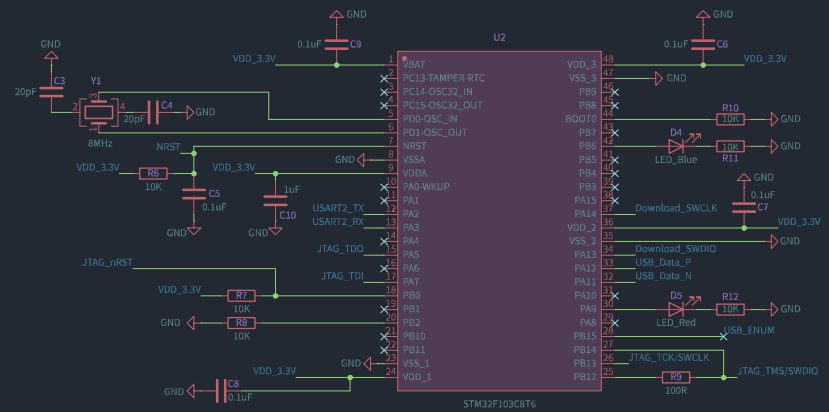

STM32F103C8T6 最小系统

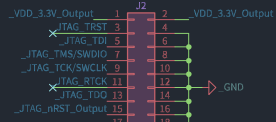

SWD-JTAG 转接板

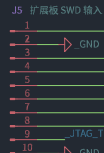
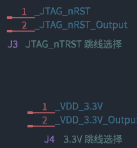

SWD/JTAG 转接板原理图

SWDIO: PA15
 TMS: PA14
 SWCLK: PA13
 JTAG nRST: PA0

SWDIO: PA15
 TMS: PA14
 SWCLK: PA13
 JTAG nRST: PA0

SWDIO: PA15
 TMS: PA14
 SWCLK: PA13
 JTAG nRST: PA0

SWDIO: PA15
 TMS: PA14
 SWCLK: PA13
 JTAG nRST: PA0